

МОДЕН

Надставка **NAD2D/120**

A	B	C		D
1	S321-113	1718	355	1/2
2	S321-114	1718	355	1/2
3	S321-117	788	354	1/2
4	S321-301	1166	354	1/2
5	S321-319	1166	354	1/2
6	S321-320	575	354	1/2
7	S321-321	575	345	1/2
8	S321-419	1166	68	1/2
9	S321-919	872	596	1/2
10	S321-918	809	596	1/2
11	LH-828	828		1/2
12	S321-008	596	530	2/2

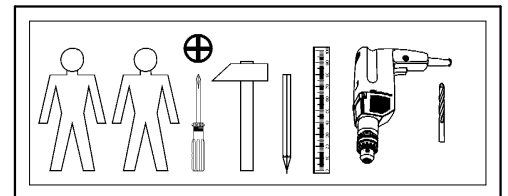
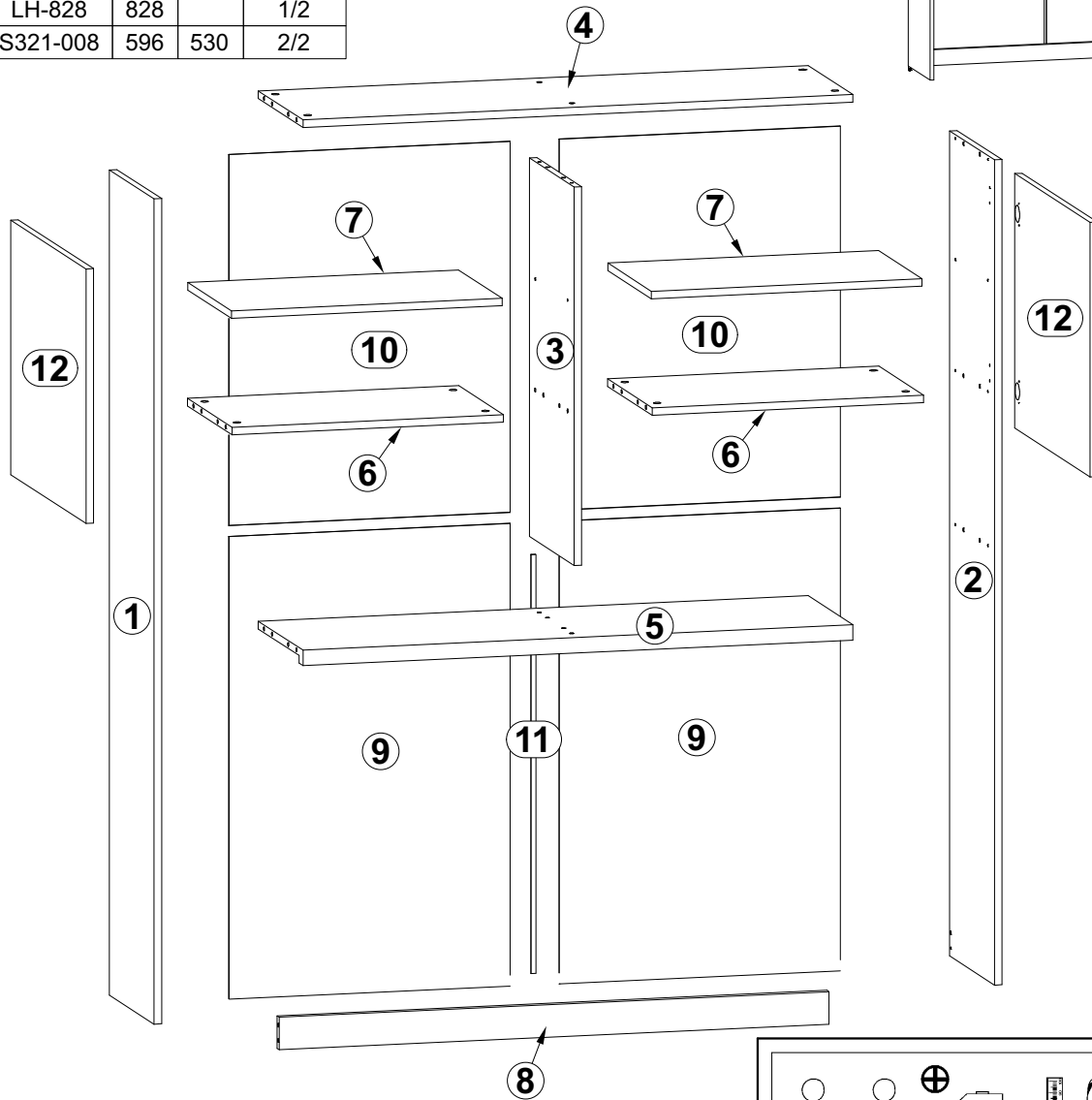
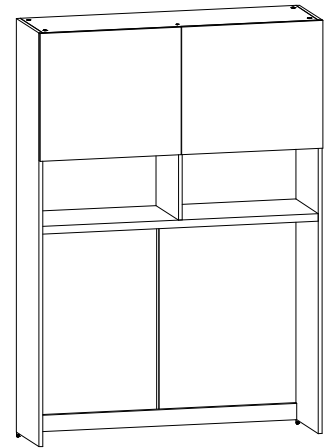

4x a44	4x b19	8x d1 φ5x17 mm	4x e1 φ7x50 mm	18x f1 φ8x30 mm	2x f6 φ8x50 mm	65x l1	1x n26v1	
2x n52 62x12/1mm	4x o21 silikon	9x p38 φ3,5x16 mm	8x p51 φ3,5x15 mm	6x p79 φ3,5x20 mm	18x r1 φ15x12mm #16	2x r10	14x r42 20/11	
2x s1	12x s2 φ16	1x z1						

1 

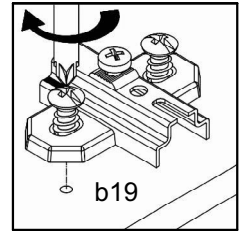
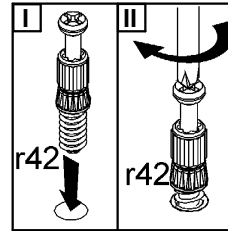
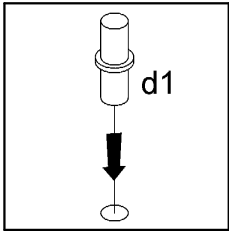
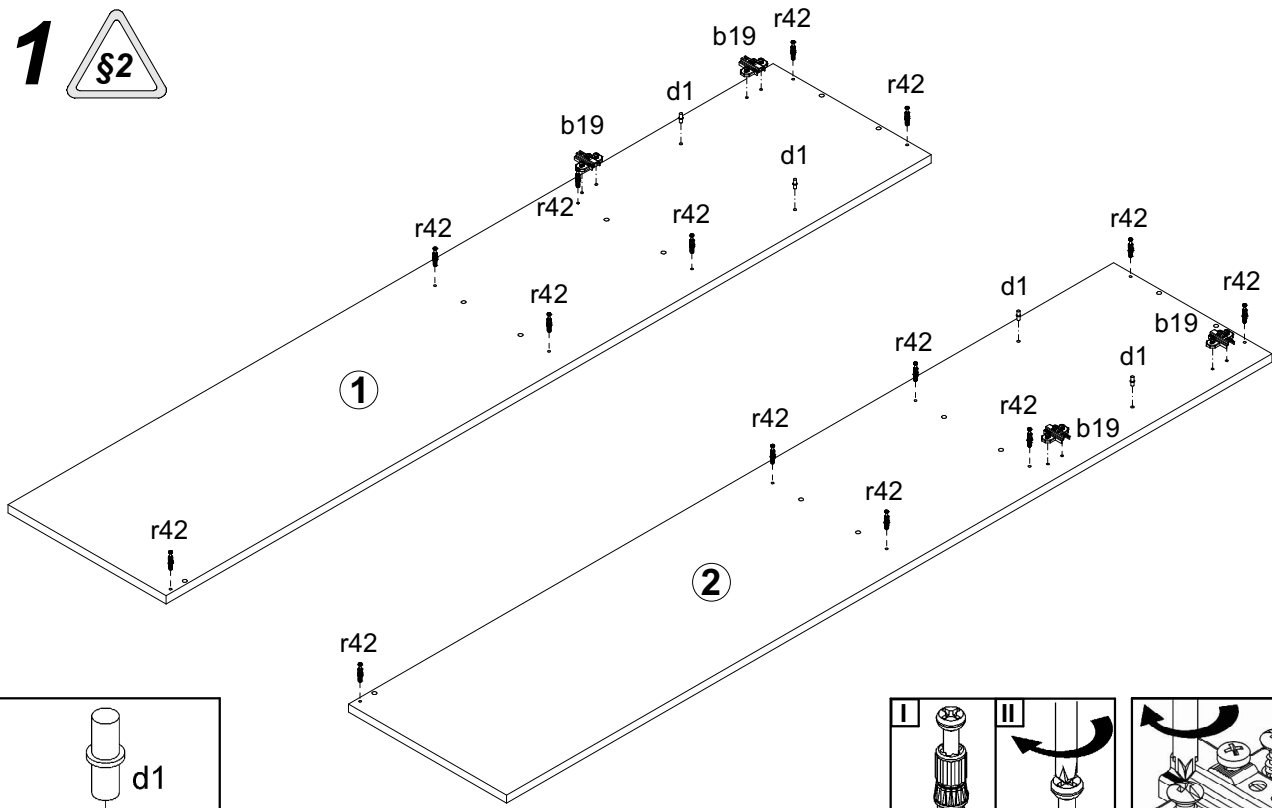

2 

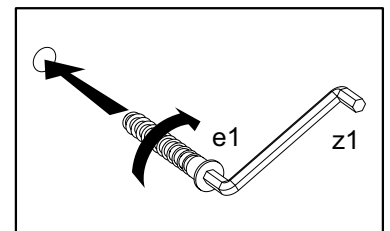
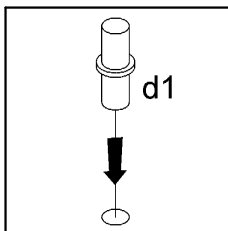
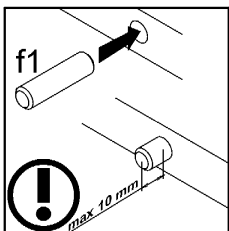
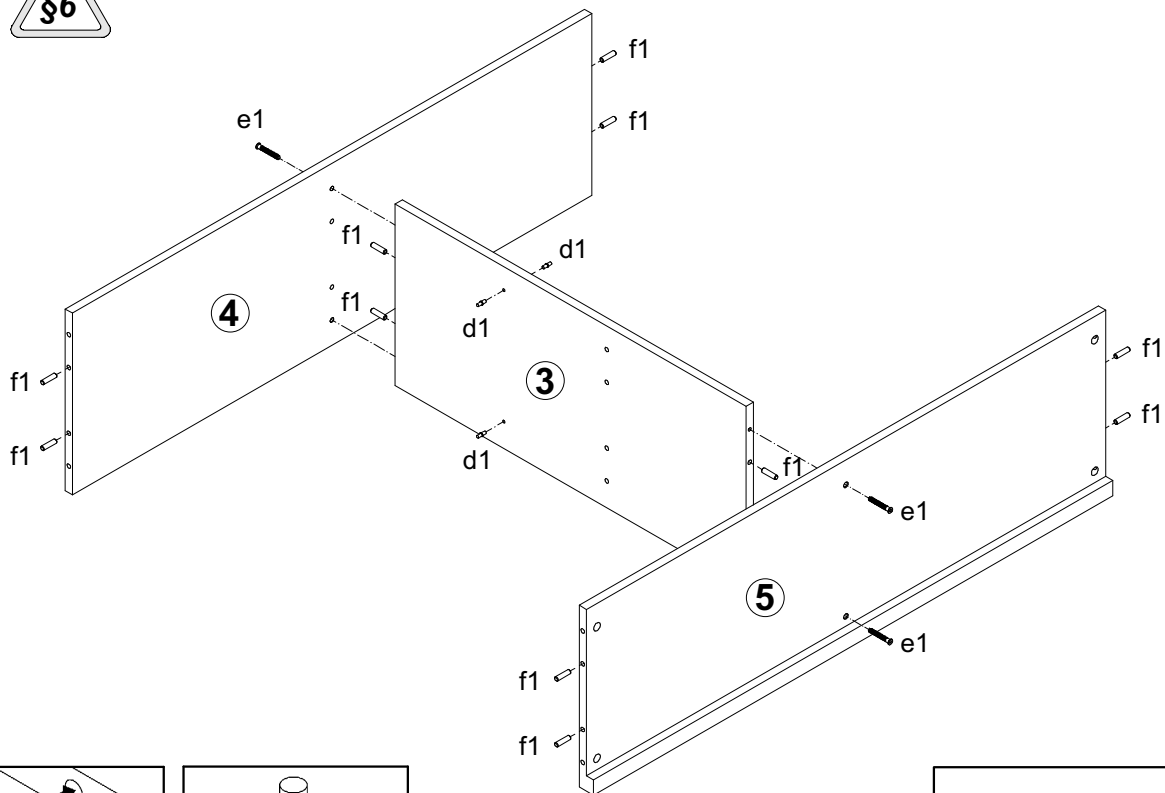

3

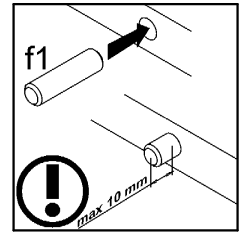
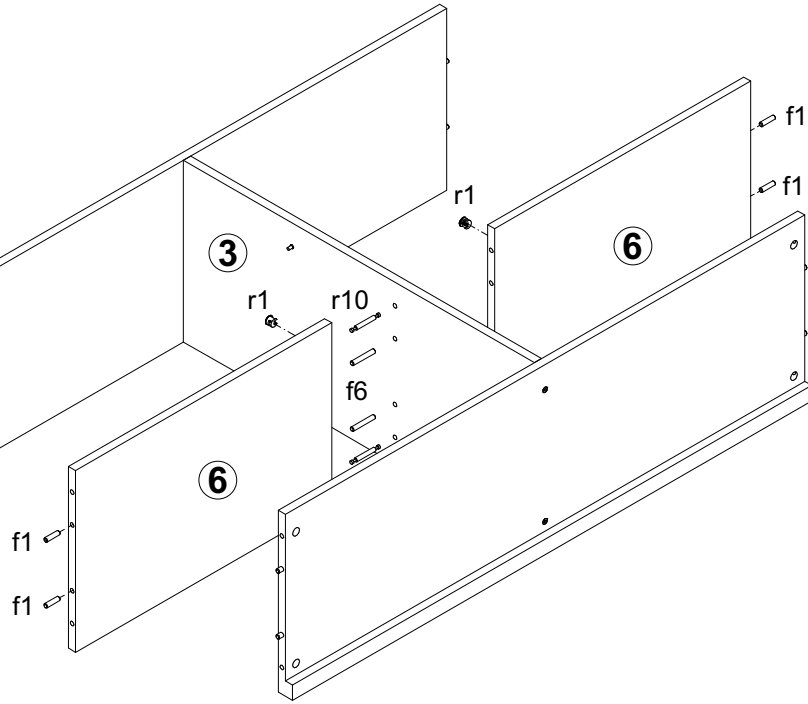

4

